

# DEVELON

Mini Excavators

## DX62R-7

## DX63-7



	DX62R	DX63
Maximum power	44.3 kW	44.3 kW
Operating weight	6216 kg	6218 kg
Bucket capacity	0.175 m <sup>3</sup>	0.175 m <sup>3</sup>

**DEVELON DX62R-7 AND DX63-7 MINI EXCAVATORS:**

# **MEET THE NEW GENERATION OF DEVELON MACHINES**

Exceptionally powerful, yet environmentally-friendly, the DX62R-7 and DX63-7 excavators features extraordinary fuel efficiency.





**DX62R**

# RAISE PROFITS, PRODUCTIVITY & FUEL EFFICIENCY

## RELIABILITY

Reinforced castings and forged steel pivot points, and strengthened heavy-duty arm and boom to withstand high-impact materials. Improved hydraulic line routing to protect your investment.

## EFFICIENCY

The auto idle function, applied as standard, increases fuel efficiency and reduces noise level.

## PRODUCTIVITY

State-of-the-art bucket, arm digging and pulling forces deliver higher productivity and reduced fuel consumption in an efficient and comfortable work environment.

## TOP PERFORMANCE IN A VERSATILE PACKAGE

- A compact & powerful machine for the best adaptability to any work site.
- High tractive effort and strong swing torque offer excellent capability for working on slopes.
- Large hydraulic capacity of a tool carrier.
- Works in narrow spaces thanks to boom swing and articulation.

## CONTROLLABILITY

Smooth and precise hydraulics drive all attachments needed on the job site.

- Operator can control flow rate proportionally.
- 2 Travel speeds with automatic auto shift.
- Boom swing, controlled from the joystick, ensures powerful and stable performance.
- Easy to read and use, the new Develon Smart Touch 8" touch screen integrates all functions and settings of your machine in one place.
- Don't miss any important call, thanks to the hands-free phone system.



The new Main Control Valve reduces internal pressure loss and matches the front hydraulic flow to the work load, so that the machine can be precisely controlled in single and complex operations. This contributes to improved performance, great fuel economy, and smooth operation.

### ENGINE

Exceptionally powerful – with high torque at low revs – the new Develon D24 engine, with DOC + DPF, combines reliability and low environmental impact. This Stage V compliant 4-cylinder engine delivers 44.3 kW at 2300 rpm.

### UNRIVALLED COMFORT

One of the most spacious cabs in the market, with low noise & vibration levels and excellent all-round visibility. Fully adjustable air suspension seat with heating functionality and improved air conditioning as standard – the DX62R-7 and DX63-7 let you focus on the job at hand in any situation.

### SAFETY

Travel alarm, optional rear and rear view camera provide maximum safety while working with people around. Large side mirrors and LED-type boom lamp and additional lights (as base), make it easy and safe to work in dark environments.

### ADVANCED FILTRATION

Highest efficiency fuel filters and cleaners remove water, dust & particles to protect your investment optimally. A filter-type high-performance water separator effectively captures moisture in the fuel, reducing impurities and helping minimize any fuel-related issues.

### EASY MAINTENANCE

Maintenance data directly available from the control panel. Easy access to all filters from ground level. Cooling compartment is equipped with fine mesh for the intake air in order to protect coolers and minimize downtime.





# ALL-ROUND VERSATILITY AND IMPROVED FUEL EFFICIENCY

## A MODEL WITH NOVEL FEATURES

Developed with the concept of providing optimum value to the end-user. The DX62R-7 (reduced tail swing) DX63-7 hydraulic excavators offer additional value to the operator. Namely:

- Increased production and improved fuel economy achieved with an electronic control for the hydraulic system and for the engine.
- Improved ergonomics, increased comfort and excellent all-round visibility, ensuring a safe and pleasant working environment.
- High-performance materials, combined with new methods of structural stress analysis, improve reliability and increase component life expectancy, thus reducing running costs.
- Reduced maintenance increases the excavator's availability and lowers the operating costs.

## GUARANTEED HIGHEST PERFORMANCE IN ANY WORK ENVIRONMENT

The advanced hydraulic system, combined with the powerful engine, provides the biggest digging and tractive forces for efficient operation. As a result, the DX62R-7 and DX63-7 provides outstanding performance, work efficiency and the ability to adapt to any work environment.

## DEVELON D24 ENGINE

The DX62R-7 and DX63-7 has a powerful and eco-friendly heart, always providing high operating efficiency and pleasant working conditions. Thanks to the turbo charger, the engine output and torque power are much stronger. This engine is also well-known for excellent fuel efficiency and reliability with long service life.

## BOOM SWING

The boom swing function allows you to work in very narrow areas.

## POWERFUL DIGGING FORCE (BUCKET)

With its power, efficiency, and increased digging force, these machines can handle every job site condition.

## DOZER BLADE

Welded, unitized blade provides durability even under harsh working conditions. Automatically controlled blade floating for quick and easy leveling operations.

## 2ND SPEED AND AUTO SHIFT

The travel motors automatically return to high speed after downshifting under load. This allows smoother turns and easier dozing work.

## RELIABILITY

Reinforced castings, forged steel pivot points, and reinforced heavy-duty arm and boom withstand high-impact materials. Large, robust boom and arm cylinders for smooth, powerful operation. Advanced pin & bushing technology.





10

8

9

11

7

5

6

13

20

19

3

15

16

12

4

18

14



# THE IDEAL WORKSPACE FOR OPERATING IN HIGH COMFORT

1. Seat
2. Arm rest
3. Quick coupler switch
4. Left-hand work lever (joystick)
5. Foot rest
6. Travel pedal
7. Cab air filter
8. Defroster vent
9. Travel lever
10. Display monitor
11. Right-hand work lever (joystick)
12. Seat belt
13. Safety lever
14. 12 V and USB power socket
15. Starter switch
16. Heater and air conditioner control panel
17. After-treatment system switch
18. Keypad
19. Boom swing switch
20. Blade control lever

## ISO-CERTIFIED SAFETY

The DX62R-7 and DX63-7 are designed to provide you with the best possible working conditions. The sophisticated state-of-the-art ROPS cab is pressurized and ISO-certified for your safety. Standard LED cab and boom lights, large side mirrors, rear-view camera, as options, give you full visibility of the machine's surroundings. Other standard safety features include: automatic overheating alarm warning, low oil pressure sensor, and engine emergency cut-off switch.

## UNRIVALLED COMFORT

Comfortably seated thanks to a high-quality heated seat with air suspension, you benefit from a clear all-round view of the work site and have easy access to several storage compartments. Pedals, joysticks and armrests have all been designed for operator comfort and efficiency. Noise and vibration levels are remarkably low, and the effectiveness of the air conditioning and automatic climate control has been increased significantly. These features allow you to continue working for hours on end without feeling tired and maximize your productivity and return on investment. Finally, thanks to the hands-free system, you won't miss any important call, and you'll stay available to your customers as you operate the machine.

## THE HIGHEST STANDARDS OF EFFICIENCY AT YOUR FINGERTIPS

Highly sensitive & low-effort joysticks and clear convenient controls enable you to work safely, smoothly & confidently with minimum effort. Proportional auxiliary flow means precision control, smoothness & efficiency when using attachments.

## DEVELON SMART TOUCH

The wide 8" touchscreen provides easy scrolling through the different menus, including power settings and auxiliary hydraulics settings. It also allows you to connect a Bluetooth device or listen to your favorite radio station.





## **MORE DURABILITY – LESS MAINTENANCE**

The most advanced technology developed by Develon Infracore Co., Ltd. has been integrated into the DX62R-7 and DX63-7 excavators for powerful performance and simple, easy maintenance. This provides the operator with convenient maintenance check points and maximizes DX62R-7's and DX63-7's work efficiency.

# SIMPLE MAINTENANCE FOR MAXIMUM UPTIME

## DEPENDABLE PERFORMANCE FOR LOW LIFETIME COST

Top quality materials, the most advanced computer-aided design, and endurance testing under the most demanding conditions ensure your excavator keeps on performing. The DX62R-7 and DX63-7 have been designed for low maintenance with longer intervals – resulting in more machine availability – while skilled Develon-trained technicians are available to provide extra support when needed.

## STRENGTHENED BOOM

Using finite elements and 3-dimensional computer simulation, the shape of the boom has been optimally designed for better load distribution throughout the structure. This enhancement, combined with increased material thickness, limit element fatigue for improved durability and reliability.

## MAINTENANCE ACCESS MADE SIMPLE

- A battery cut-off switch makes it easy to disconnect the battery during long-term storage.
- The hour meter display can be easily checked from ground level.
- For extra accessibility and servicing convenience, all filters (engine oil filter, fuel pre-filter, fuel filter and pilot filter) are accessible from ground level.
- Placing MCV on the right side of the machine improves its maintainability and work visibility.
- Fine mesh on the side doors and on the cooler itself filters the intake air going to the cooler for better cooling performance and reduced maintenance.

## RUBBER TRACKS

The rubber tracks offer greater non-slip and grip capabilities and are less harmful to sidewalks and road surfaces in urban environments. These rubber tracks can be easily installed or removed with the idler, sprocket and other main parts. The reinforced seal type upper rollers make our traveling system even more durable. The result: longer traveling time and distance, especially in harsher environments. Because the Lower Roller Steel/Rubber shoes are dual flange type, they can be replaced without changing undercarriage components – ensuring increased lateral lifting force.

## ENGINE ROOM

The engine compartment is designed for easier service, and the sturdy sound-proofing inside the engine cover reduces the noise to provide a more comfortable environment for the operator and those working around the machine. The clips make disassembling easy and convenient.

## OIL GAUGE

Hydraulic oil level can be easily checked through the gauge on the right side of the hydraulic tank.

## GREASE PIPING

Integrated grease piping is designed for easy maintenance of the swing bearing and boom swing cylinder.



# TECHNICAL SPECIFICATIONS

## ENGINE

Designed to deliver superior performance and fuel efficiency, the Develon D24 diesel engine fully meets the latest Stage V emission regulations. To optimize machine performance, the engine uses high-pressure fuel injectors, air-to-air inter-cooler and electronic engine controls. 4-Cycle Water-Cooled, Wastegate Turbocharged, Diesel Oxidation Catalyst (DOC), Diesel Particulate Filter (DPF) and EGR.

### Model

Develon D24

### No. of cylinders

4

### Rated power at 2200 rpm

SAE J1995 44.3 kW (65 hp)

### Max. torque at 1600 rpm

260 Nm

### Idle (low - high)

1000 - 2300 rpm

### Displacement

2392 cm<sup>3</sup>

### Bore × stroke

90 mm × 94 mm

### Starter

12 V / 2.5 kW

### Batteries - Alternator

1 × 12 V, 100 Ah – 12 V, 90 A

### Air filter

Double element air cleaner

## UNDERCARRIAGE

Extremely robust construction throughout – made of high-quality, durable materials, with all welded structures designed to limit stresses.

- Track rollers lubricated for life
- Idlers and sprockets fitted with floating seals
- Track shoes made of induction-hardened alloy with triple grouser \*
- Heat-treated connecting pins

### Upper rollers (standard shoe)

1

### Lower rollers

5

### Number of links & shoes per side \*

39

### Link pitch \*

135 mm

\* for steel track option

## HYDRAULIC SYSTEM

The e-EPOS (Electronic Power Optimising System) is the brain of the excavator – minimising fuel consumption and optimizing the efficiency of the hydraulic system for all working conditions. To harmonize the operation of the engine and the hydraulics, the e-EPOS is connected to the engine's electronic control unit (ECU) via a data transfer link.

- 2 travel speeds offer either increased torque or high speed
- Load-sensing pump system for fuel savings
- Auto-deceleration system
- 4 operating modes, 4 power modes
- Flow and pressure control of auxiliary hydraulic circuits from control panel
- Computer-aided pump flow control

### Main pump

Variable axial piston pump

Maximum flow at 2300 rpm 144.9 l/min

	Relief valve settings	
	DX62R-7	DX63-7
Implement	280 kgf/cm <sup>2</sup>	
Travel	280 kgf/cm <sup>2</sup>	
Swing	220 kgf/cm <sup>2</sup>	

## HYDRAULIC CYLINDERS

High-strength steel piston rods and cylinder bodies. Shock-absorbing mechanism fitted in all cylinders for shock-free operation and extended piston life.

Cylinders	Quantity	Bore × rod diameter × stroke (mm)
Boom	1	105 × 65 × 665
Arm (Standard)	1	85 × 55 × 737
Arm (Available)	1	85 × 55 × 816
Bucket	1	75 × 45 × 600
Dozer	1	110 × 60 × 183
Boom swing	1	95 × 55 × 449

## CAB

The air-conditioning and heating systems are integrated for optimal climate control. An automatically-controlled fan supplies the pressurized and filtered cab air, which is distributed throughout the cab from multiple vents.

The heated air suspension, adjustable operator's seat includes a seat belt. The operator can adjust the ergonomic seat and joystick console separately according to his preferences.

### **A-weighted emission sound pressure level at the operator's position, LpAd (ISO 6396:2008)**

Declared: 73 dB(A)

Measured: 72 dB(A)

### **A-weighted sound power level, LwAd (2000/14/EC)**

Declared: 98 dB(A)

Measured: 97 dB(A)

## SWING MECHANISM

The swing mechanism uses an axial piston motor, driving a 2-stage planetary reduction gear bathed in oil for maximum torque.

- Swing bearing: single-row, shear type ball bearing with induction hardened internal gear
- Internal gear and pinion immersed in lubricant

### **Maximum swing speed**

9.8 rpm

### **Maximum swing torque**

1380 kgf·m

## FLUID CAPACITIES

Fuel tank	78 l
Cooling system (radiator)	8.5 l
Hydraulic oil tank	67 l
Engine oil	9.2 l
Travel device	2 × 0.9 l

## DRIVE

Each track is driven by an independent, high-torque axial piston motor through a planetary reduction gearbox. Two levers/foot pedals guarantee smooth travel with counter-rotation on demand. The track frame protects the travel motor, brake and planetary gears. The multi-disc track brakes are spring-applied and hydraulic released.

### **Travel speed (low - high)**

2.8 - 4.7 km/h

### **Maximum traction**

4.58 t

### **Maximum gradeability**

35° / 70%

## WEIGHT & GROUND PRESSURE

	Machine weight (kg)		Ground pressure (kgf/cm <sup>2</sup> )	
	DX62R-7	DX63-7	DX62R-7	DX63-7
400 mm rubber shoes	6216	6218	0.353	0.353
400 mm steel tracks	6400	6402	0.369	0.369

# TECHNICAL SPECIFICATIONS

## COMPONENT WEIGHTS

Item	Weight (kg)		Remarks
	DX62R-7	DX63-7	
Upper structure without front	3363	3367	Without counterweight
Counterweight	830		
Lower structure assembly	2015		Rubber
Front assembly	842		With 0.175 bucket
Boom assembly	239		2.9 boom
Arm assembly	147		1.9 arm
Bucket	141		0.18 bucket
Boom cylinder	77.6		Lock v/v excluded
Arm cylinder	60		Lock v/v excluded
Bucket cylinder	34		Lock v/v excluded
Dozer	285		
Dozer cylinder	44		

## ARMS

	Length (mm)	Weight (kg)	Digging forces (ISO) (ton)
DX62R-7/DX63-7 (Standard)	1600	114	2.8
DX62R-7/DX63-7 (Available)	1900	148	2.8

## BUCKETS

	Capacity (m³) SAE	Width (mm)		Weight (kg)	Digging forces (ISO) (ton)
		With side cutters	W/O side cutters		
DX62R-7 (Standard)	0.175	712.5	638	141	4.4
DX63-7 (Standard)					

# DIMENSIONS

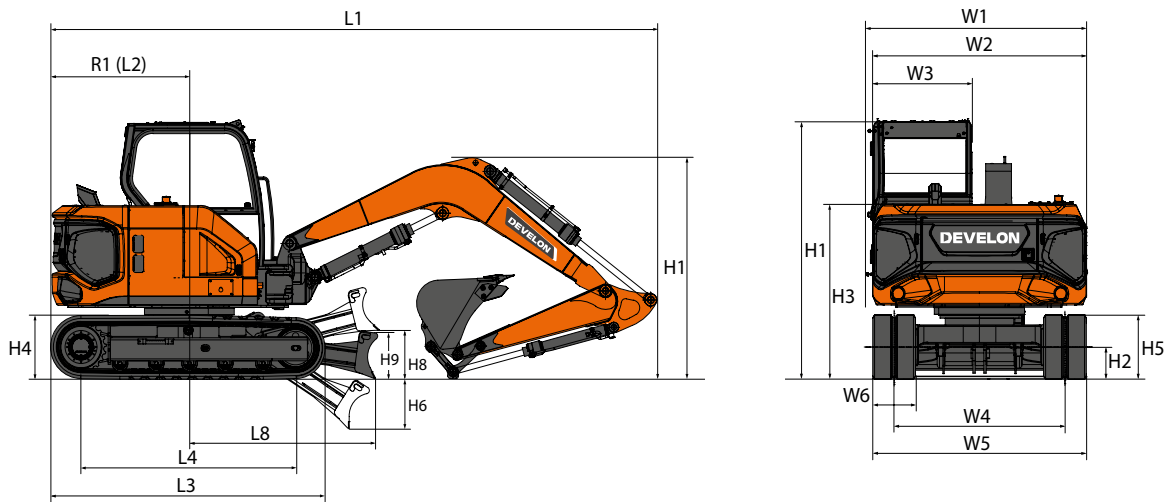

## DIMENSIONS

		Unit	DX62R-7	DX63-7
<b>Boom length</b>		mm	<b>2900</b>	<b>2900</b>
<b>Arm length</b>		mm	<b>1900</b>	<b>1900</b>
<b>Bucket capacity</b>		m <sup>3</sup>	<b>0.175</b>	<b>0.175</b>
<b>Undercarriage (track + grouser)</b>		-	<b>Rubber</b>	<b>Rubber</b>
L1	Overall length	mm	5631	5571
H1	Overall height	Boom	2385	
		Cab	2575	
W1	Overall width	mm	1980	
R1	Rear swing radius	mm	1180	1350
H2	Ground clearance	mm	208	
L2	Rear end distance	mm	1180	1350
W2	House width	mm	1750	
W3	Cab width	mm	1150	
H3	Height over cover	mm	1588	
H4	Counterweight clearance	mm	628	
A1/A2	Boom swing angle (left/right)	°	60/53	
H5	Track height	mm	562	
L3	Track length	mm	2486	
L4	Tumbler distance	mm	1990	
W4	Track gauge	mm	1580	
W5	Undercarriage width	mm	1980	
W6	Shoe width	mm	400	
etc.	Grouser/lug height	mm	20	
H6	Dozer digging depth	mm	460	
H8	Dozer lift clearance	mm	488	
H9	Dozer blade height	mm	410	
L8	Distance to dozer end	mm	1840	

# WORKING RANGE

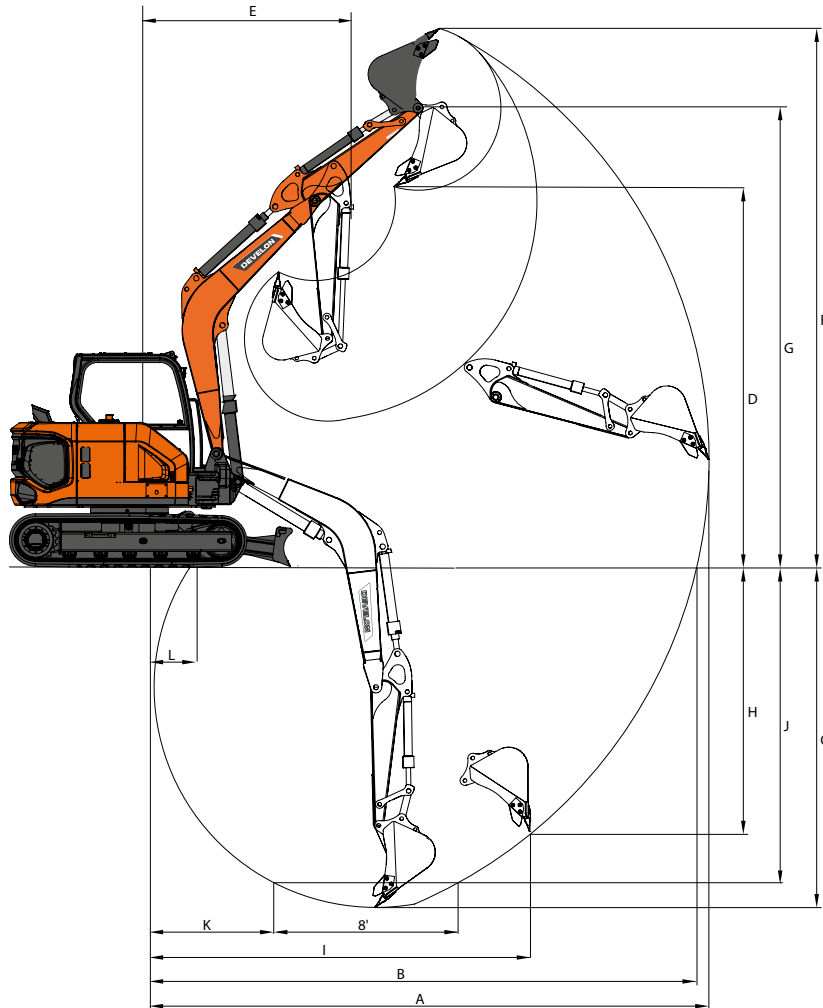

## WORKING RANGE















	Unit	DX62R-7		DX63-7	
<b>Boom length</b>	<b>mm</b>	<b>2900</b>		<b>2900</b>	
<b>Arm length</b>	<b>mm</b>	<b>1900</b>	<b>1600</b>	<b>1900</b>	<b>1600</b>
<b>Bucket capacity</b>	<b>m<sup>3</sup></b>	<b>0.175</b>		<b>0.175</b>	
A Max. digging reach	mm	6610	6310	6440	6140
B Max. digging reach (ground)	mm	6485	6175	6315	6005
C Max. digging depth	mm	4095	3795	4095	3795
D Max. dumping height	mm	4270	4040	4270	4040
E Min. swing radius	mm	2850	2685	2680	2515
F Max. digging height	mm	6025	5790	6025	5790
G Max. bucket pin height	mm	5155	4925	5155	4925
H Max. vertical wall depth	mm	2580	2380	2580	2380
I Max. radius vertical	mm	5155	4935	4985	4765



# LIFTING CAPACITIES DX62R-7

DX62R-7 • MONO BOOM • W/O BUCKET • COUNTERWEIGHT 0,83 T

(UNIT: 1000 KG)

B	A		1.0 m		2.0 m		3.0 m		4.0 m		5.0 m		Max. reach	
														

**Arm 1.6 m • Shoe 400 mm Rubber • Dozer up**

5.0 m													1.35 *	1.35 *	3.25
4.0 m								1.27	1.16				1.02 *	0.97	4.42
3.0 m								1.26	1.15	0.87	0.79		0.85	0.78	5.04
2.0 m					1.9	1.7		1.21	1.1	0.86	0.78		0.76	0.7	5.35
1.0 m					1.77	1.58		1.16	1.05	0.83	0.76		0.74	0.67	5.42
0.0 m					1.71	1.52		1.12	1.01	0.82	0.74		0.76	0.69	5.26
-1.0 m	2.36 *	2.36 *	2.88 *	2.88 *	1.7	1.51		1.11	1				0.85	0.78	4.84
-2.0 m			3.59	3.05	1.73	1.54		1.13	1.03				1.11	1.01	4.07

**Arm 1.6 m • Shoe 400 mm Rubber • Dozer down**

5.0 m													1.35 *	1.35 *	3.25
4.0 m								1.37 *	1.16				1.02 *	0.97	4.42
3.0 m								1.44 *	1.15	1.09 *	0.79		0.93 *	0.78	5.04
2.0 m					2.30 *	1.7		1.73 *	1.1	1.52 *	0.78		0.91 *	0.7	5.35
1.0 m					3.17 *	1.58		2.07 *	1.05	1.64 *	0.76		0.95 *	0.67	5.42
0.0 m					3.48 *	1.52		2.28 *	1.01	1.70 *	0.74		1.05 *	0.69	5.26
-1.0 m	2.36 *	2.36 *	2.88 *	2.88 *	3.32 *	1.51		2.23 *	1				1.28 *	0.78	4.84
-2.0 m			4.43 *	3.05	2.70 *	1.54		1.69 *	1.03				1.59 *	1.01	4.07



**Arm 1.9 m • Shoe 400 mm Rubber • Dozer up**

5.0 m													1.36	1.24	3.79
4.0 m								1.16 *	1.16 *				0.92	0.84	4.80
3.0 m								1.25 *	1.15	0.87	0.79		0.76	0.69	5.36
2.0 m					1.92	1.72		1.21	1.1	0.85	0.77		0.69	0.63	5.65
1.0 m					1.77	1.58		1.15	1.04	0.82	0.74		0.66	0.6	5.72
0.0 m					1.68	1.5		1.1	0.99	0.79	0.72		0.68	0.62	5.57
-1.0 m	1.98 *	1.98 *	2.58 *	2.58 *	1.66	1.48		1.08	0.97	0.79	0.72		0.75	0.68	5.18
-2.0 m	3.38 *	3.38 *	3.51	2.97	1.68	1.49		1.09	0.98				0.94	0.85	4.48
-3.0 m			2.74 *	2.74 *	1.55 *	1.55 *							1.30 *	1.30 *	3.19

**Arm 1.9 m • Shoe 400 mm Rubber • Dozer down**

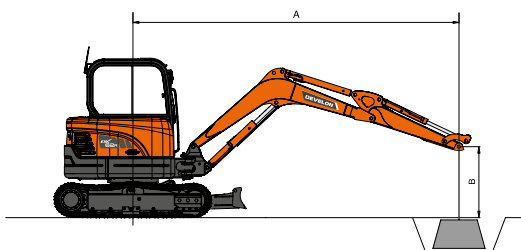
5.0 m													1.42 *	1.24	3.79
4.0 m								1.16 *	1.16 *				1.20 *	0.84	4.80
3.0 m								1.25 *	1.15	1.29 *	0.79		1.11 *	0.69	5.36
2.0 m					1.95 *	1.72		1.56 *	1.1	1.40 *	0.77		1.09 *	0.63	5.65
1.0 m					2.91 *	1.58		1.94 *	1.04	1.55 *	0.74		1.12 *	0.6	5.72
0.0 m					3.40 *	1.5		2.20 *	0.99	1.66 *	0.72		1.23 *	0.62	5.57
-1.0 m	1.98 *	1.98 *	2.58 *	2.58 *	3.38 *	1.48		2.24 *	0.97	1.61 *	0.72		1.45 *	0.68	5.18
-2.0 m	3.38 *	3.38 *	4.64 *	2.97	2.92 *	1.49		1.93 *	0.98				1.49 *	0.85	4.48
-3.0 m			2.74 *	2.74 *	1.55 *	1.55 *							1.30 *	1.30 *	3.19

















 : Rating over front.  
 : Rating over side or 360°.

1. Load point is the end of the arm.
2. Capacities marked with an asterisk (\*) are limited by hydraulic capacities.
3. Lift capacities shown do not exceed 75% of minimum tipping loads or 87% of hydraulic capacities.
4. The least stable position is over the side.
5. Lift capacities apply only to the machine as originally manufactured and normally equipped by the manufacturer.
6. Lift capacities are in compliance with ISO 10567.

# LIFTING CAPACITIES DX63-7

DX63-7 • MONO BOOM • W/O BUCKET • COUNTERWEIGHT 0,83 T

(UNIT: 1000 KG)

B	A		1.0 m		2.0 m		3.0 m		4.0 m		5.0 m		Max. reach		A
															

## Arm 1.6 m • Shoe 400 mm Rubber • Dozer up

5.0 m													1.35 *	1.35 *	3.08
4.0 m								1.41 *	1.3				1.02 *	1.02 *	4.25
3.0 m								1.41	1.29				0.93 *	0.93 *	4.87
2.0 m					2.14	1.93	1.36	1.25	0.97	0.89			0.91 *	0.84	5.18
1.0 m					2.01	1.81	1.31	1.2	0.95	0.87			0.88	0.81	5.25
0.0 m					1.95	1.75	1.28	1.16	0.93	0.86			0.91	0.84	5.09
-1.0 m	2.35 *	2.35 *	3.16 *	3.16 *	1.94	1.74	1.27	1.15					1.03	0.94	4.67
-2.0 m	3.93 *	3.93 *	4.00 *	3.46	1.97	1.77							1.34	1.23	3.90

## Arm 1.6 m • Shoe 400 mm Rubber • Dozer down

5.0 m													1.35 *	1.35 *	3.08
4.0 m								1.41 *	1.3				1.02 *	1.02 *	4.25
3.0 m								1.43 *	1.29				0.93 *	0.93 *	4.87
2.0 m					2.15 *	1.93	1.68 *	1.25	1.50 *	0.89			0.91 *	0.84	5.18
1.0 m					2.89 *	1.81	1.97 *	1.2	1.59 *	0.87			0.95 *	0.81	5.25
0.0 m					3.20 *	1.75	2.15 *	1.16	1.62 *	0.86			1.05 *	0.84	5.09
-1.0 m	2.35 *	2.35 *	3.16 *	3.16 *	3.08 *	1.74	2.10 *	1.15					1.28 *	0.94	4.67
-2.0 m	3.93 *	3.93 *	4.00 *	3.46	2.51 *	1.77							1.59 *	1.23	3.90



## Arm 1.9 m • Shoe 400 mm Rubber • Dozer up

5.0 m													1.42 *	1.42 *	3.62
4.0 m								1.19 *	1.19 *				1.1	1.01	4.63
3.0 m								1.26 *	1.26 *	0.97	0.9		0.91	0.84	5.19
2.0 m					1.86 *	1.86 *	1.36	1.24	0.96	0.88			0.82	0.76	5.48
1.0 m					2.01	1.81	1.3	1.19	0.93	0.86			0.8	0.73	5.55
0.0 m					1.93	1.73	1.26	1.14	0.91	0.84			0.82	0.75	5.40
-1.0 m	1.99 *	1.99 *	2.86 *	2.86 *	1.9	1.7	1.24	1.13	0.91	0.83			0.91	0.83	5.01
-2.0 m	3.48 *	3.48 *	3.97	3.38	1.92	1.72	1.25	1.14					1.14	1.04	4.31
-3.0 m			2.49 *	2.49 *	1.33 *	1.33 *							1.30 *	1.30 *	3.02

## Arm 1.9 m • Shoe 400 mm Rubber • Dozer down

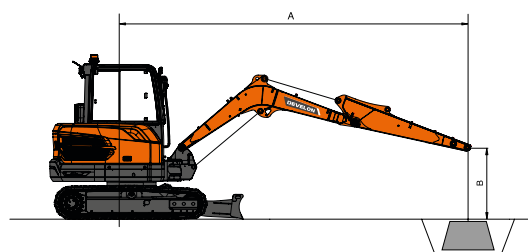
5.0 m													1.42 *	1.42 *	3.62
4.0 m								1.19 *	1.19 *				1.20 *	1.01	4.63
3.0 m								1.26 *	1.26 *	1.31 *	0.9		1.11 *	0.84	5.19
2.0 m					1.86 *	1.86 *	1.52 *	1.24	1.38 *	0.88			1.09 *	0.76	5.48
1.0 m					2.66 *	1.81	1.85 *	1.19	1.51 *	0.86			1.12 *	0.73	5.55
0.0 m					3.11 *	1.73	2.08 *	1.14	1.60 *	0.84			1.23 *	0.75	5.40
-1.0 m	1.99 *	1.99 *	2.86 *	2.86 *	3.12 *	1.7	2.12 *	1.13	1.49 *	0.83			1.45 *	0.83	5.01
-2.0 m	3.48 *	3.48 *	4.50 *	3.38	2.71 *	1.72	1.79 *	1.14					1.49 *	1.04	4.31
-3.0 m			2.49 *	2.49 *	1.33 *	1.33 *							1.30 *	1.30 *	3.02



 : Rating over front.  
 : Rating over side or 360°.

1. Load point is the end of the arm.
2. Capacities marked with an asterisk (\*) are limited by hydraulic capacities.
3. Lift capacities shown do not exceed 75% of minimum tipping loads or 87% of hydraulic capacities.
4. The least stable position is over the side.
5. Lift capacities apply only to the machine as originally manufactured and normally equipped by the manufacturer.
6. Lift capacities are in compliance with ISO 10567.

# OPTIONAL ATTACHMENTS

## NEED A BREAK?



Available on 1 to 10 tons Excavators

### OPTIMIZED PERFORMANCE

HB series are optimized for Develon Excavators, fully certified by Develon engineering.

### PERFORMANCE

Develon HB breakers offer powerful performance and top notch productivity, whether you are demolishing concrete or breaking rocks.

### WARRANTY

Avoid compatibility and warranty coverage arguments from using non-approved breaker. Develon offers standard warranty up to 2 years.

### TOTAL COST OF OWNERSHIP

Even with 2-year warranty, HB-series are offered at reasonable price, providing customer benefits in total cost of ownership.

## BUCKETS SETS

Whatever the width, tackle any digging operation with our buckets sets.

Available on 1 to 10 tons Excavators

Each set contains:

- 1 pin-on quick coupler
- 3 digging buckets with teeth
- 1 grading bucket

### SIDE CUTTERS & BOTTOM WEAR STRAPS

The digging buckets are equipped with thick and chamfered side cutters, and bottom wear straps covering 90% of the bottom of the bucket.

### INCREASED STIFFNESS

The grading bucket is equipped with one or more web plates to increase the stiffness of the bucket.



## JOB SITE MANAGEMENT

## WORK EFFICIENCY MANAGEMENT

## PREVENTIVE MAINTENANCE

## PROACTIVE SERVICE

### OPERATION TREND

Total operation hours and operation hours by mode

### FUEL EFFICIENCY\*

Fuel level and fuel consumption

### LOCATION

GPS and geo-fence

### REPORTS

Operation report & utilization

### WARNING & ALERT

Detect machine warnings, antenna disconnection, and geo/time fence

### FILTER & OIL MANAGEMENT

Preventive maintenance by item replacement cycle

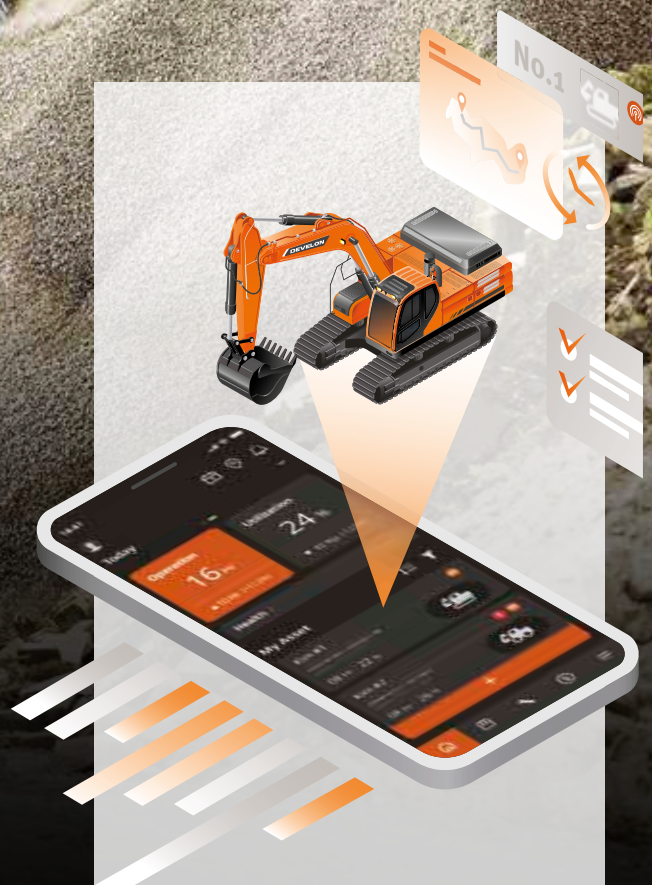

### TELEMATICS TERMINAL

Terminal device is installed and connected to a machine to capture machine data.

### TELECOMMUNICATION

Develon provides dual-mode (Mobile, Satellite) communication to maximize communication coverage.

### DEVELON FLEET MANAGEMENT WEB

Users can monitor machine status from Develon Fleet Management Web.

# STANDARD AND OPTIONAL EQUIPMENT

● Standard ○ Optional

## Engine

---

- Develon D24 - Common rail diesel engine with direct fuel injection, Stage V compliant
- Auto-idle function

## Hydraulic system

---

- Variable pistons pump
- Breaker piping with direct return to the tank
- 2-way high flow auxiliary line with settings from the display panel
- Cylinder cushioning & contamination seals
- Rotation line (Pero)
- Quick coupler line

## Cab & interior

---

- Pressurized, sound-insulated cab
- Air suspension seat with heater
- Air conditioning
- Pull-up type front window and removable lower front window
- Sliding right windows with lock
- Ceiling light
- Intermittent upper windshield wiper
- Multiple storage compartments
- Flat, spacious, easy-to-clean floor
- Cup holder
- Anti-theft protection
- DEVELON Smart Touch – 8" touch screen, all-in-one
- Electric horn
- Engine speed (RPM) control dial
- Hydrostatic 2-speed travel system with manual or automatic shift
- DAB radio with handsfree call system
- USB charger & 12 V power socket
- Serial communication port for laptop PC interface
- Adjustable PPC for arm, boom, bucket and swing, with sliding proportional control for attachments and auxiliary hydraulic buttons
- Travel pedals and hand levers
- Master key

## Safety

---

- Roll Over Protective Structure (ROPS)
- Boom and arm cylinder safety valves
- Overload warning device
- Rotating beacon
- Hydraulic safety lock lever
- Safety glass
- Hammer for emergency escape
- Right and left rearview mirrors
- Emergency engine stop switch
- Reinforced cast steel pivot points
- Battery cut-off switch
- LED boom light
- Lockable fuel cap
- LED lights (2× on top of the cab)
- Falling Objects Guard System – top and front cab guards (ISO 10262 level II and SAE J1356)
- Rear camera

## Other

---

- DX62R-7: 2900 mm mono boom – 1600 mm arm – 830 kg counterweight
- DX63-7: 2900 mm mono boom – 1600 mm arm – 830 kg counterweight
- Develon Fleet Management (telematic system)
- Boom cylinder guard
- Double element air cleaner
- Self-diagnostic function
- Battery (12 V, 100 Ah), alternator (12 V, 80 A)
- Remote greasing for swing circle and workgroup pivot points
- DX62R-7: 1900 mm arm
- DX63-7: 1900 mm arm

## Undercarriage

---

- Fixed undercarriage
- Hydraulic track adjuster
- 400 mm rubber tracks
- Dozer blade with floating function
- 400 mm steel tracks (greased and sealed track links)
- Dozer lock valve (not compatible with floating dozer)

## List of attachments

---

- Buckets set (= 1 hydraulic quick coupler QC45 + 3 digging buckets 110 l - 450 mm / 160 l - 600 mm / 250 l - 900 mm + 1 grading bucket 300 l - 1500 mm)
- Develon Hydraulic Breaker HB06H, 500-900 bpm, 120 dB







# Powered by Innovation

DISCOVER MORE:  
DX62R-7

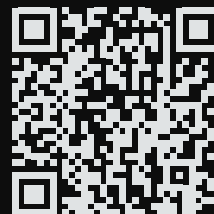

DX63-7



# DEVELON

HD Hyundai Infracore Europe s.r.o.  
IBC - Pobřežní 620/3, 186 00 Praha 8-Karlín  
Czech Republic

©2023 DEVELON D4601250-EN (08-23)

Certain specification(s) are based on engineering calculations and are not actual measurements. Specification(s) are provided for comparison purposes only and are subject to change without notice. Specification(s) for your individual Develon equipment will vary based on normal variations in design, manufacturing, operating conditions, and other factors. Pictures of Develon units may show other than standard equipment.