

DEVELON

Crawler Excavators

DX140LC-7K

DX160HT-7K



| | DX140LC-7K | DX160HT-7K |
|------------------|---------------------|---------------------------|
| Maximum power | 115 hp | 115 hp |
| Operating weight | 14.4 t | 16.8 t |
| Bucket capacity | 0.51 m ³ | 0.5 - 0.75 m ³ |



DEVELON DX140LC-7K / DX160HT-7K CRAWLER EXCAVATOR:

MEET THE NEW GENERATION OF DEVELON MACHINES

Lift your business to the next level with the
DX140LC-7K/DX160HT-7K Develon excavator.

Exceptionally powerful, yet environmentally friendly,
the DX140LC-7K/DX160HT-7K excavator features extraordinary
fuel efficiency.



RAISE PROFITS, PRODUCTIVITY & FUEL EFFICIENCY

RELIABILITY

Reinforced castings and forged steel pivot points and reinforced heavy duty arm and boom to withstand high-impact materials. Mono boom or articulated boom for added versatility. Improved hydraulic line routing to protect your investment.

VERSATILITY

A new attachment mode, with a priority valve on the attachment, results in higher working efficiency when moving the arm and using the attachment at the same time.

YOUR SAFETY IS OUR PRIORITY

Rear and right side cameras as standard, anti-slip steps and platforms, as well as guard rails on upper structure. Optional: a 360° all-around view camera (AVM) can be linked with unique ultrasonic detection for maximum safety while working with people around. Large side mirrors, powerful LED work lights (2 x additional lights possible as an option), travel alarm.

PRODUCTIVITY

State-of-the-art bucket and arm digging forces. Delivers higher productivity and reduced fuel consumption in an efficient and comfortable work environment.

UNRIVALLED COMFORT

One of the most spacious cabs in the market, with low noise & vibration levels and excellent all-round visibility. Thanks to the heating and even an optional cooling functionality of the premium seat and improved air ventilation in the DX140LC-7K, you can focus on the job at hand in any situation.





OPERATE AT EASE

New Develon Smart Touch screen, an easy to read and use 8" touch screen integrates all functions and settings of your machine in one place. Don't miss any important call thanks to the hands-free phone system. And forget fumbling with keyholes: unlock the door remotely, and start or stop the engine with the included Develon Smart Key.

ENGINE

Exceptionally powerful – with high torque at low revs – the new Develon engine combines reliability and low environmental impact. This Stage V compliant 4 cylinder engine delivers 86 kW at 2000 rpm.

FULL CONTROL OVER FUEL CONSUMPTION

The latest evolution of the legendary Stage V Develon D34 engine achieves greater fuel savings thanks to the 3rd generation of Smart Power Control (SPC3). Take full control over your fuel consumption with the settable engine shut off.

ADVANCED FILTRATION

Highest efficiency filters & cleaners remove water, dust & particles to protect your investment optimally.

EASY MAINTENANCE

Maintenance data directly available from control panel. Easy access to all filters from ground level. Cooling compartment equipped with fine mesh for the intake air, to protect coolers and minimize downtime.



TOP PERFORMANCE AND FUEL EFFICIENCY

THE POWER TO RAISE PRODUCTIVITY

- The DX140LC-7K is equipped with the latest generation Develon engine
- Stage V compliant, this engine boasts extremely low emissions because reducing our environmental impact is paramount to us
- Exhaust gases are purified by Selective Catalytic Reduction (SCR) technology, a Diesel Oxidation Catalyst (DOC) and a Diesel Particulate Filter (DPF) with no maintenance before 5000 hours

EFFICIENT FUEL MANAGEMENT

- Choice of 4 power modes (Eco - Standard - Power - Power Plus) and automatic Smart Power Control system for optimal power and reduced fuel consumption in all conditions
- Engine auto-shut-off: shuts down the engine after the machine has been idling for a specified time. The operator can set the delay before shut-off via the Develon Smart Touch screen

VARIABLE PRESSURE TURBOCHARGER

Provides optimal air flow to the engine combustion chamber under all speed and load conditions, so that exhaust gas is cleaner and fuel economy is improved.

SPC3 (SMART POWER CONTROL)

2 systems (Variable Speed Control and Pump Torque Control) work together to improve efficiency while maintaining productivity. The system reduces the engine speed and adjusts the pump torque according to work conditions.

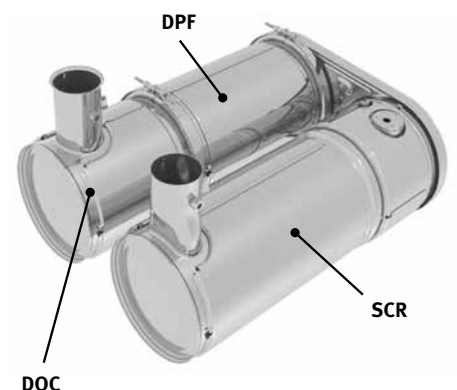



RELIABILITY – THE HABIT OF A LIFETIME

In your profession, you need equipment you can depend on. At Develon, we put durability and reliability at the core of our machines' development. Our materials and structures undergo stringent testing for strength and resilience under the most extreme conditions.

DESIGNED FOR LONG-TERM, ALL-ROUND, HEAVY DUTY PERFORMANCE

EXTRA-STRONG X CHASSIS

Designed using finite element analysis and 3D computer simulation, the X shaped undercarriage ensures optimum structural integrity and durability.

UNDERCARRIAGE DURABILITY

- The chain is composed of sealed, self-lubricating links for long-term dependability
- The track spring and idler are joined for long-lasting performance and easy maintenance
- Cast steel heavy duty sprockets guarantee the highest resistance
- The track rollers are lubricated for life

STRENGTHENED BOOM AND ARM

During the development of our machines, we use intensive testing to calculate the best load distribution throughout the boom structure.

Combined with thicker material, this means that element fatigue is limited and both reliability and component life are increased. To better protect the base of the arm, reinforced bars have been added and the arm center and end boss have been strengthened.

ADVANCED FILTRATION

- Fuel filters and water separator: a filter-type high-performance water separator effectively captures moisture in the fuel, reducing impurities and helping minimize any fuel-related issues. Pre-filters and dual main filters as standard achieve a high degree of purity that minimizes fuel system failures.

PIN AND BUSHING ADVANCED TECHNOLOGY

Highly lubricated metal is used for the boom pivot to increase the component's lifetime and lengthen greasing intervals. The bucket pivot features EM (Enhanced Macrosurface) bushings. These have a tailored surface pattern and self-lubricating coating for optimized greasing and more efficient debris removal. Ultra-hard wear-resistant discs and bucket pivot polymer shims increase durability even more.





1

4

2

5

3

6

7

9

13

12

10

1. Sun visor
2. Window grip
3. Parallel wiper
4. 360° all-around view camera (AVM) (optional)
5. Develon Smart Touch
6. Redesigned pedals
7. Flat, spacious, easy-to-clean floor
8. Keyless start (Develon Smart Key)
9. Joysticks and switches are integrated in adjustable control consoles
10. Heated and cooled (option) seat
11. Improved visibility on the bottom right
12. Storage compartment for sunglasses
13. Separate seat height adjustment lever and cushion tilting function

OPERATING IN HIGH COMFORT

BEST-IN-CLASS OPERATOR ENVIRONMENT

The DX140LC-7K is designed to provide you with the best possible working conditions. The sophisticated state-of-the-art ROPS cab is pressurized and ISO-certified for your safety. A high-quality heated seat (and even seat cooling available as an option) with air suspension provides maximum operator comfort.

UNRIVALLED COMFORT

Comfortably seated, you benefit from a clear all-round view of the work site and have easy access to several storage compartments. Pedals, joysticks and armrests have all been designed for operator comfort and efficiency. Noise and vibration levels are remarkably low, and the effectiveness of the air conditioning and automatic climate control has been increased significantly. These features allow you to continue working for hours on end without feeling tired.

Finally, thanks to the hands-free system, you won't miss any important call, and you'll stay available to your customers, as you operate the machine.

CAB SUSPENSION

The cab's suspension system (CabSus mount) dampens vibrations and provides outstanding protection against impact. This system absorbs shocks and vibrations much more effectively than a conventional silentblock suspension system.

DEVELON SMART TOUCH

The wide 8" touchscreen provides easy scrolling through the different menus, including power settings and auxiliary hydraulics settings. It also allows you to connect a Bluetooth device or listen to your favorite radio station.

360° ALL-AROUND VIEW CAMERA (AVM) SYSTEM (OPTION)

The 360° all-around view camera (AVM) system gives you full view of the machine's surroundings.





TAKE A SEAT IN BUSINESS CLASS

The ergonomic controls, the easy-to-view color monitor, and Develon Smart Touch place the machine firmly in your hands.

TOTAL CONTROL IN ALL SIMPLICITY

DYNAMIC POWER MANAGEMENT

- Automatic travel speed range selection (slow/fast)
- Activating the power boost control system increases digging force by 10%
- A 1-touch deceleration button immediately reduces engine speed to low idle
- Auto-idling starts 4 seconds (adjustable) after all controls are returned to neutral – reducing fuel consumption and noise levels in the cab

INTELLIGENT FLOATING BOOM MODE (OPTIONAL)

The “intelligent floating boom” function allows the boom to move up and down freely according to the application:

- Hydraulic breaker setting: during boom down operation, the boom moves down freely under its own weight. The result is reduced shock and vibration and longer breaker service life
- Full float setting: during boom down selection, the boom is allowed to rise and fall as required while the bucket is drawn across the ground

4 WORK MODES AND 4 POWER MODES

These modes deliver the needed power, according to your specific application, while minimizing fuel consumption:

- Work modes: 1-way mode, 2-way mode, Digging mode and Lifting mode
With the 2-way mode, we now have a priority valve on the attachment line to increase the machine's productivity when using an attachment and moving the arm at the same time.
- Power modes: Power Plus mode, Power mode, Standard mode, Economy mode

EXPERT FINGERTIP CONTROL

- The new multi-function 8" Develon Smart Touch screen displays all useful information in a visual and intuitive format.
- At a glance, you can check the machine's status and settings to achieve optimal efficiency.
- Develon's unique jog shuttle switch gives you easy and precise control over all machine functions.
- Highly sensitive and low-effort joysticks enable you to work safely, smoothly and confidently.
- The proportional thumb switches* on the joysticks can be mounted horizontally or vertically, as the operator prefers, for optimal control of hydraulic attachments.

*when no Pero option, no thumb switch on left manipulator





SIMPLE MAINTENANCE FOR MAXIMUM UPTIME

MAINTENANCE ACCESS MADE SIMPLE

- Large guard rails are installed along with anti-slip steps and plates, for safer, easier access to the whole upper structure.
- The air conditioning filter is placed on the side of the cab for easy access. The filter's cover can be locked and opened with a key.
- A battery cut-off switch makes it easy to disconnect the battery for long-term storage.
- The hour meter display can be easily checked from ground level.
- Shut-off valves have been fitted on the pre-filter piping line and fuel tank drain piping to make servicing easier and prevent pollution from leakage.
- Engine parts can be easily reached via the top and side panels.
- For extra accessibility and servicing convenience, all filters (engine oil filter, fuel pre-filters, fuel filters and pilot filter) are located in the pump compartment.

ADBLUE® TANK

Connected to the ECU, sensors in the tank detect low levels of AdBlue® or any other system malfunction. Also equipped with an AdBlue® level indicator during refilling, to avoid over filling.

CENTRALIZED GREASING POINTS

To make maintenance easier, the greasing points have been centralized. An automatic lubrication system is available as an option.



TECHNICAL SPECIFICATIONS DX140LC-7K

ENGINE

Designed to deliver superior performance and fuel efficiency, the Develon G2 D34 diesel engine fully meets the latest Stage V emission regulations. To optimize machine performance, the engine uses high-pressure fuel injectors, air-to-air inter-cooler and electronic engine controls. 4-Cycle Water-Cooled, Wastegate Turbocharged, Diesel Oxidation Catalyst (DOC) & Selective Catalytic Reduction (SCR) and Diesel Particulate Filter (DPF), without EGR.

Model

Develon G2 D34

No. of cylinders

4

Rated power at 2000 rpm

SAE J1995 86 kW (115 hp)
SAE J1349 81.6 kW (109 hp)

Max. torque at 1400 rpm

46.9 kgf·m

Idle (low - high)

950 [±10] - 2000 [±25] rpm

Displacement

3409 cm³

Bore × stroke

98 mm × 113 mm

Starter

24 V / 5 kW

Batteries - Alternator

2 × 12 V, 100 Ah – 24 V, 100 A

Air filter

Double element air cleaner

UNDERCARRIAGE

Extremely robust construction throughout – made of high-quality, durable materials, with all welded structures designed to limit stresses.

- Track rollers lubricated for life
- Idlers and sprockets fitted with floating seals
- Track shoes made of induction-hardened alloy with triple grouser
- Heat-treated connecting pins
- Hydraulic track adjuster with shock-absorbing tension mechanism

Upper rollers (standard shoe)

1

Lower rollers

7

Number of links & shoes per side

46

Link pitch

171.45 mm

HYDRAULIC SYSTEM

The e-EPOS (Electronic Power Optimising System) is the brain of the excavator – minimising fuel consumption and optimizing the efficiency of the hydraulic system for all working conditions. To harmonize the operation of the engine and the hydraulics, the e-EPOS is connected to the engine's electronic control unit (ECU) via a data transfer link.

- 2 travel speeds offer either increased torque or high speed
- Cross-sensing pump system for fuel savings
- Auto-deceleration system
- 4 operating modes, 4 power modes
- Flow and pressure control of auxiliary hydraulic circuits from control panel
- Computer-aided pump flow control

Main pump

2 × variable displacement tandem axial piston pump
Maximum flow at 2000 rpm 2 × 114 l/min

Pilot pump

Gear pump
Maximum flow at 2000 rpm 30 l/min

Relief valve settings

| | |
|-----------|-------------------------|
| Implement | 330 kgf/cm ² |
| Travel | 350 kgf/cm ² |
| Swing | 275 kgf/cm ² |
| Pilot | 40 kgf/cm ² |

HYDRAULIC CYLINDERS

High-strength steel piston rods and cylinder bodies. Shock-absorbing mechanism fitted in all cylinders for shock-free operation and extended piston life.

| Cylinders | Quantity | Bore × rod diameter × stroke (mm) |
|--------------------------|----------|-----------------------------------|
| Mono boom | 2 | 110 × 75 × 1085 |
| Articulated boom | 2 | 110 × 75 × 970 |
| Arm for mono boom | 1 | 115 × 80 × 1108 |
| Arm for articulated boom | 1 | 115 × 80 × 1068 |
| Bucket | 1 | 100 × 70 × 900 |

CAB

The air-conditioning and heating systems are integrated for optimal climate control. An automatically-controlled fan supplies the pressurized and filtered cab air, which is distributed throughout the cab from multiple vents.

The heated air suspension, adjustable operator's seat includes a seat belt. The operator can adjust the ergonomic seat and joystick console separately according to his preferences.

A-weighted emission sound pressure level at the operator's position, LpAd (ISO 6396:2008)

Declared: 69 dB(A)

A-weighted sound power level, LwAd (2000/14/EC)

Declared: 100 dB(A)

Measured: 99 dB(A)

SWING MECHANISM

The swing mechanism uses an axial piston motor, driving a 2-stage planetary reduction gear bathed in oil for maximum torque.

- Swing bearing: single-row, shear type ball bearing with induction hardened internal gear
- Internal gear and pinion immersed in lubricant

Maximum swing speed

10.13 rpm

Maximum swing torque

4888 kgf·m

FLUID CAPACITIES

| | |
|---------------------------|---------|
| Fuel tank | 265 l |
| Cooling system (radiator) | 27.1 l |
| AdBlue® (DEF) tank | 25 l |
| Hydraulic oil tank | 145 l |
| Engine oil | 12.6 l |
| Swing drive | 3 l |
| Travel device | 2 × 2 l |

DRIVE

Each track is driven by an independent, high-torque axial piston motor through a planetary reduction gearbox. Two levers / foot pedals guarantee smooth travel with counter-rotation on demand. The track frame protects the travel motor, brake and planetary gears. The multi-disc track brakes are spring-applied and hydraulic released.

Travel speed (low - high)

2.9 - 4.7 km/h

Maximum traction

15.2 t

Maximum gradeability

35° / 70%

WEIGHT

| | Shoe width (mm) | Machine weight (kg) | Ground pressure (kgf/cm ²) |
|--------------------------|-----------------|---------------------|--|
| Triple grouser | 500 | 14200 | 0.43 |
| | 600 (STD) | 14400 | 0.37 |
| | 700 | 14600 | 0.32 |
| Rubber shoe (road liner) | 500 | 14100 | 0.43 |

COMPONENT WEIGHTS

| Item | Unit | Weight | Remarks |
|--|------|-----------------|--------------------|
| Upper structure without front (mono boom) | kg | 6898 | With counterweight |
| Upper structure without front (articulated boom) | kg | 6986 | With counterweight |
| Lower structure assembly | kg | 5007 | |
| Counterweight | kg | 2200 | |
| Front assembly | kg | 2434 | |
| 4.6 m mono boom | kg | 780 | Including bushing |
| 4.98 m articulated boom (upper / lower) | kg | 592 / 381 | Including bushing |
| Arm (2.1 m / 2.5 m / 3.0 m) | kg | 370 / 414 / 456 | Including bushing |

TECHNICAL SPECIFICATIONS DX140LC-7K

BUCKETS

| Bucket Type | Capacity (m ³) SAE | Width (mm) | | Weight (kg) | 4600 mm mono boom | | | 4980 mm articulated boom | |
|-------------|--------------------------------|-------------------|------------------|-------------|-------------------|-------------|-------------|--------------------------|-------------|
| | | With side cutters | W/O side cutters | | 2100 mm arm | 2500 mm arm | 3000 mm arm | 2100 mm arm | 2500 mm arm |
| GP | 0.24 | 534 | 464 | 275 | A | A | A | A | A |
| | 0.39 | 820 | 736 | 341 | A | A | A | A | A |
| | 0.45 | 911 | 821 | 381 | A | A | A | A | A |
| | 0.51 | 991 | 907 | 393 | A | A | A | A | B |
| | 0.59 | 1081 | 997 | 413 | A | B | C | B | C |
| | 0.64 | 1167 | 1083 | 435 | A | B | C | C | D |
| | 0.76 | 1339 | 1255 | 484 | C | C | D | D | D |
| DC Class | 0.45 | - | 1500 | 357 | A | A | A | A | A |
| | 0.54 | - | 1800 | 403 | A | A | B | A | B |
| H Class | 0.31 | 642 | 600 | 372 | A | A | A | A | A |
| | 0.42 | 792 | 750 | 420 | A | A | A | A | A |
| | 0.52 | 942 | 900 | 478 | A | A | B | B | C |
| | 0.60 | 1042 | 1000 | 510 | A | B | C | C | D |
| | 0.67 | 1142 | 1100 | 542 | B | C | D | C | D |
| | 0.74 | 1242 | 1200 | 585 | C | D | - | D | - |

A: Suitable for materials with a density less than or equal to 2100 kg/m³

B: Suitable for materials with a density less than or equal to 1800 kg/m³

C: Suitable for materials with a density less than or equal to 1500 kg/m³

D: Suitable for materials with a density less than or equal to 1200 kg/m³

Based on ISO 10567 and SAE J296, arm length without quick-coupler. For reference only.

DEVELON BUCKETS

4 More - More choice - More durable - More strength - More performance!

General Construction Bucket



The General purpose bucket is designed for digging and re-handling soft to medium materials (e.g. materials with low wear characteristics such as top-soil, loam, coal).

Heavy Construction Bucket



The Heavy duty bucket is designed for mass excavations in dense materials such as hard packed clay, shot limestone, limited rock content and gravel.

Severe Mining Bucket



The Severe duty bucket is designed for durability in digging compact materials like loose or blasted rock, hard packed clay and stone.

X-treme Mining Bucket



The X-treme duty bucket is designed as a long-life version of the Severe duty bucket for digging in the most abrasive materials.

DIMENSIONS DX140LC-7K

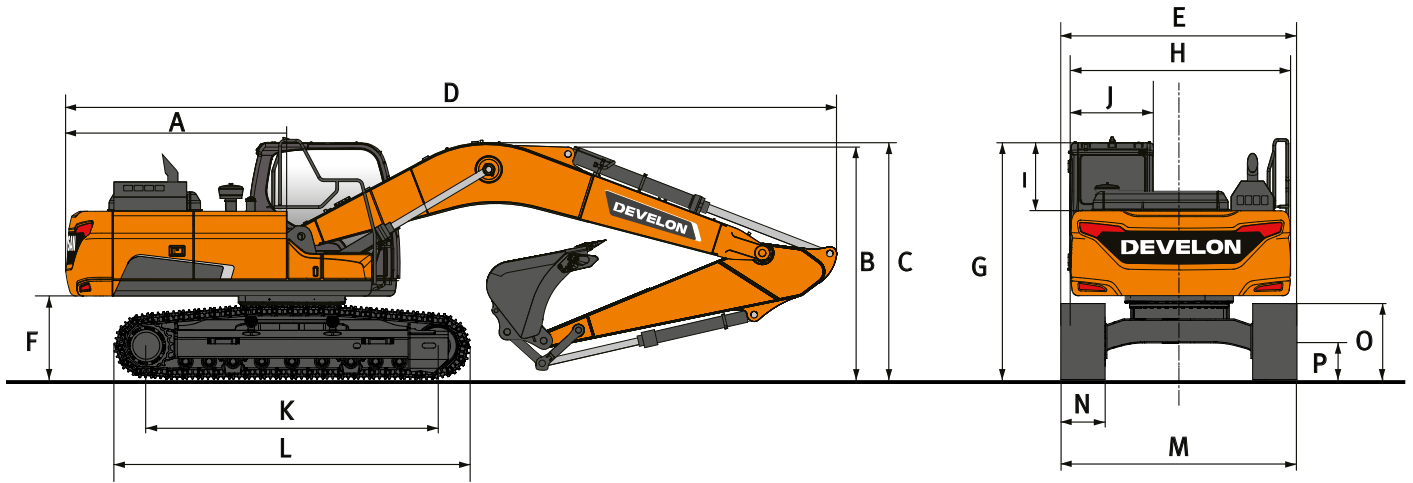

DIMENSIONS

| | Unit | Mono boom | | | Articulated boom | |
|------------------------------|----------------------|-------------|-------------|-------------|------------------|-------------|
| | | 4600 | 2500 | 3000 | 2100 | 2500 |
| Boom length | mm | | | | 4980 | |
| Arm length | mm | 2100 | 2500 | 3000 | 2100 | 2500 |
| Bucket capacity | m³ | 0.59 | 0.51 | 0.45 | 0.51 | 0.45 |
| A Tail swing radius | mm | 2205 | 2205 | 2205 | 2205 | 2205 |
| B Shipping height (boom) | mm | 2480 | 2635 | 3065 | 2615 | 2800 |
| C Shipping height (hose) | mm | 2640 | 2820 | 3180 | 2840 | 3000 |
| D Shipping length | mm | 7690 | 7685 | 7640 | 8050 | 7975 |
| E Shipping width | mm | 2590 | 2590 | 2590 | 2590 | 2590 |
| F Counterweight clearance* | mm | 895 | 895 | 895 | 895 | 895 |
| G Height over cab | mm | 2785 | 2785 | 2785 | 2785 | 2785 |
| H House width | mm | 2540 | 2540 | 2540 | 2540 | 2540 |
| I Cab height above house | mm | 840 | 840 | 840 | 840 | 840 |
| J Cab width | mm | 1010 | 1010 | 1010 | 1010 | 1010 |
| K Tumbler distance | mm | 3035 | 3035 | 3035 | 3035 | 3035 |
| L Track length | mm | 3755 | 3755 | 3755 | 3755 | 3755 |
| M Undercarriage width STD/LC | mm | 2590 | 2590 | 2590 | 2590 | 2590 |
| N Shoe width | mm | 600 | 600 | 600 | 600 | 600 |
| O Track height* | mm | 795 | 795 | 795 | 795 | 795 |
| P Ground clearance* | mm | 410 | 410 | 410 | 410 | 410 |

* : without grouser

WORKING RANGE DX140LC-7K

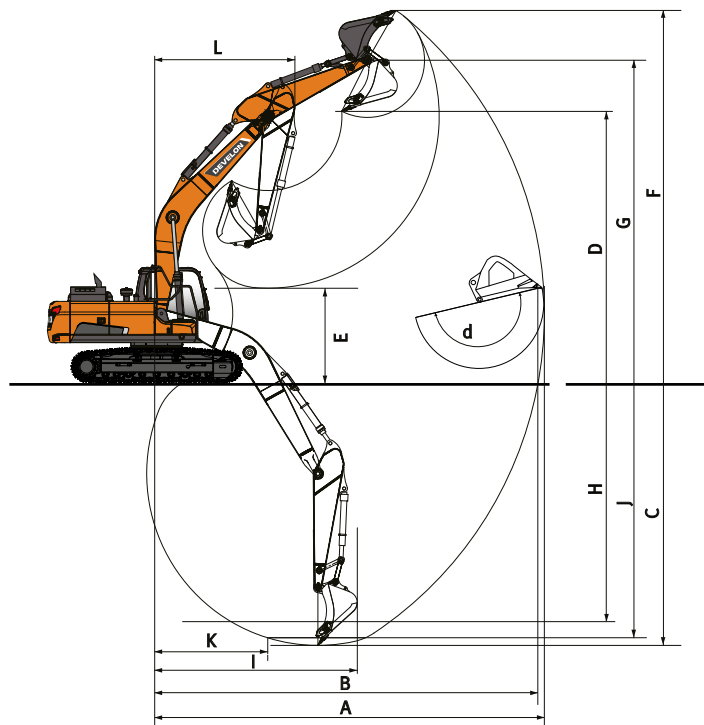

WORKING RANGE

| | Unit | Mono boom | | | Articulated boom | |
|---------------------------------|----------------------|-------------|-------------|-------------|------------------|-------------|
| Boom length | mm | 4600 | | | 4980 | |
| Arm length | mm | 2100 | 2500 | 3000 | 2100 | 2500 |
| Bucket capacity | m³ | 0.59 | 0.51 | 0.45 | 0.51 | 0.45 |
| A Max. digging reach | mm | 7815 | 8285 | 8665 | 8260 | 8720 |
| B Max. digging reach (ground) | mm | 7660 | 8140 | 8530 | 8115 | 8585 |
| C Max. digging depth | mm | 5235 | 5635 | 6135 | 5405 | 5835 |
| D Max. loading height | mm | 5865 | 6315 | 6440 | 6395 | 6855 |
| E Min. loading height | mm | 2575 | 2230 | 1725 | 3070 | 2715 |
| F Max. digging height | mm | 8150 | 8660 | 8745 | 8730 | 9235 |
| G Max. bucket pin height | mm | 7080 | 7535 | 7655 | 7615 | 8075 |
| H Max. vertical wall depth | mm | 3710 | 4495 | 4685 | 3895 | 4200 |
| I Max. radius vertical | mm | 5745 | 5605 | 5970 | 6180 | 6525 |
| J Max. digging depth (8' level) | mm | 4910 | 5395 | 5890 | 5285 | 5725 |
| K Min. radius 8' level | mm | 1805 | 1915 | 1825 | 895 | 900 |
| L Min. swing radius | mm | 2285 | 2600 | 2625 | 2775 | 2970 |
| d Bucket angle | ° | 174 | 174 | 174 | 174 | 174 |











DIGGING FORCES (ISO)

| | Unit | Mono boom | | | Articulated boom | |
|---------------------------|----------------------|-------------|-------------|-------------|------------------|-------------|
| Boom length | mm | 4600 | | | 4980 | |
| Arm length | mm | 2100 | 2500 | 3000 | 2100 | 2500 |
| Bucket capacity | m³ | 0.59 | 0.51 | 0.45 | 0.51 | 0.45 |
| BUCKET (Normal/Press. Up) | ton | 10.5/11.1 | 10.5/11.1 | 10.5/11.1 | 10.5/11.1 | 10.5/11.1 |
| ARM (Normal/Press. Up) | ton | 7.2/7.7 | 6.2/6.5 | 5.6/6.0 | 7.2/7.7 | 6.2/6.5 |

LIFTING CAPACITIES DX140LC-7K

MONO BOOM • W/O BUCKET

(UNIT: 1000 KG)

| A | 1.5 m | | 3.0 m | | 4.5 m | | 6.0 m | | Max. reach | | |
|---|---|---|---|---|---|---|---|---|---|---|---|
| |  |  |  |  |  |  |  |  |  |  | A |

Mono boom 4.6 m • Arm 2.5 m • Shoe 500 mm • Counterweight 2.2 t • Dozer up

| | | | | | | | | | | | |
|--------|--------|--------|---------|--------|--------|--------|--------|------|--------|--------|------|
| 7.5 m | | | | | | | | | 2.74 * | 2.74 * | 3.61 |
| 6.0 m | | | | | 3.64 * | 3.64 * | | | 2.16 * | 2.16 * | 5.42 |
| 4.5 m | | | | | 3.92 * | 3.92 * | 3.18 * | 2.65 | 2.00 * | 2.00 * | 6.39 |
| 3.0 m | | | 6.64 * | 6.64 * | 4.92 * | 3.99 | 3.63 | 2.59 | 1.99 * | 1.99 * | 6.91 |
| 1.5 m | | | 8.33 * | 6.77 | 5.50 | 3.75 | 3.52 | 2.49 | 2.10 * | 1.95 | 7.07 |
| 0.0 m | | | 7.17 * | 6.48 | 5.30 | 3.58 | 3.43 | 2.41 | 2.36 * | 1.99 | 6.90 |
| -1.5 m | 5.40 * | 5.40 * | 10.35 * | 6.46 | 5.23 | 3.52 | 3.41 | 2.38 | 2.89 * | 2.21 | 6.37 |
| -3.0 m | 9.21 * | 9.21 * | 9.81 * | 6.57 | 5.29 | 3.57 | | | 4.07 | 2.83 | 5.37 |

Mono boom 4.6 m • Arm 2.5 m • Shoe 500 mm • Counterweight 2.2 t • Dozer down

| | | | | | | | | | | | |
|--------|--------|--------|---------|--------|--------|--------|--------|------|--------|--------|------|
| 7.5 m | | | | | | | | | 2.74 * | 2.74 * | 3.61 |
| 6.0 m | | | | | 3.64 * | 3.64 * | | | 2.16 * | 2.16 * | 5.42 |
| 4.5 m | | | | | 3.92 * | 3.92 * | 3.18 * | 3.16 | 2.00 * | 2.00 * | 6.39 |
| 3.0 m | | | 6.64 * | 6.64 * | 4.92 * | 4.81 | 4.31 * | 3.10 | 1.99 * | 1.99 * | 6.91 |
| 1.5 m | | | 8.33 * | 8.33 * | 6.18 * | 4.56 | 4.84 * | 2.99 | 2.10 * | 2.10 * | 7.07 |
| 0.0 m | | | 7.17 * | 7.17 * | 7.08 * | 4.38 | 5.27 * | 2.91 | 2.36 * | 2.36 * | 6.90 |
| -1.5 m | 5.40 * | 5.40 * | 10.35 * | 8.22 | 7.30 * | 4.32 | 5.30 * | 2.88 | 2.89 * | 2.67 | 6.37 |
| -3.0 m | 9.21 * | 9.21 * | 9.81 * | 8.35 | 6.60 * | 4.37 | | | 4.20 * | 3.42 | 5.37 |

Mono boom 4.6 m • Arm 3.0 m • Shoe 700 mm • Counterweight 2.2 t • Dozer up

| | | | | | | | | | | | |
|--------|--------|--------|---------|--------|--------|--------|--------|------|--------|--------|------|
| 7.5 m | | | | | | | | | 2.42 * | 2.42 * | 4.34 |
| 6.0 m | | | | | | | | | 2.05 * | 2.05 * | 5.91 |
| 4.5 m | | | | | 3.35 * | 3.35 * | 3.20 * | 2.78 | 1.94 * | 1.94 * | 6.81 |
| 3.0 m | | | 5.41 * | 5.41 * | 4.38 * | 4.18 | 3.78 | 2.70 | 1.96 * | 1.96 * | 7.30 |
| 1.5 m | | | 8.90 * | 7.14 | 5.72 * | 3.91 | 3.66 | 2.58 | 2.08 * | 1.87 | 7.45 |
| 0.0 m | | | 8.35 * | 6.69 | 5.49 | 3.70 | 3.55 | 2.48 | 2.34 * | 1.89 | 7.29 |
| -1.5 m | 5.20 * | 5.20 * | 10.12 * | 6.59 | 5.38 | 3.60 | 3.49 | 2.43 | 2.85 * | 2.06 | 6.79 |
| -3.0 m | 8.19 * | 8.19 * | 10.41 * | 6.65 | 5.39 | 3.62 | | | 3.64 | 2.53 | 5.87 |
| -4.5 m | | | 7.94 * | 6.89 | | | | | 5.36 * | 4.09 | 4.25 |



Mono boom 4.6 m • Arm 3.0 m • Shoe 700 mm • Counterweight 2.2 t • Dozer down

| | | | | | | | | | | | |
|--------|--------|--------|---------|--------|--------|--------|--------|--------|--------|--------|------|
| 7.5 m | | | | | | | | | 2.42 * | 2.42 * | 4.34 |
| 6.0 m | | | | | | | | | 2.05 * | 2.05 * | 5.91 |
| 4.5 m | | | | | 3.35 * | 3.35 * | 3.20 * | 3.20 * | 1.94 * | 1.94 * | 6.81 |
| 3.0 m | | | 5.41 * | 5.41 * | 4.38 * | 4.38 * | 3.95 * | 3.54 | 1.96 * | 1.96 * | 7.30 |
| 1.5 m | | | 8.90 * | 8.90 * | 5.72 * | 5.26 | 4.56 * | 3.42 | 2.08 * | 2.08 * | 7.45 |
| 0.0 m | | | 8.35 * | 8.35 * | 6.81 * | 5.03 | 5.10 * | 3.31 | 2.34 * | 2.34 * | 7.29 |
| -1.5 m | 5.20 * | 5.20 * | 10.12 * | 9.61 | 7.27 * | 4.93 | 5.33 * | 3.26 | 2.85 * | 2.75 | 6.79 |
| -3.0 m | 8.19 * | 8.19 * | 10.41 * | 9.69 | 6.93 * | 4.94 | | | 4.03 * | 3.39 | 5.87 |
| -4.5 m | | | 7.94 * | 7.94 * | | | | | 5.36 * | 5.36 * | 4.25 |

Mono boom 4.6 m • Arm 3.0 m • Shoe 700 mm • Counterweight 2.2 t • Without dozer

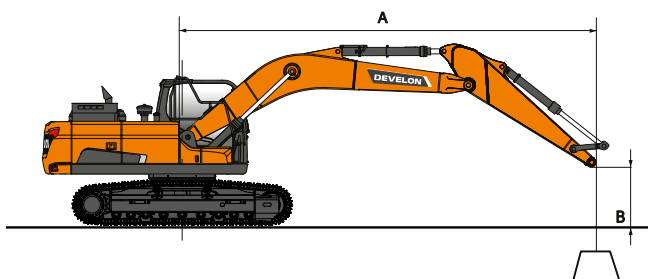
| | | | | | | | | | | | |
|--------|--------|--------|---------|--------|--------|--------|--------|------|--------|--------|------|
| 7.5 m | | | | | | | | | 2.42 * | 2.42 * | 4.34 |
| 6.0 m | | | | | | | | | 2.05 * | 2.05 * | 5.91 |
| 4.5 m | | | | | 3.35 * | 3.35 * | 3.20 * | 2.61 | 1.94 * | 1.94 * | 6.81 |
| 3.0 m | | | 5.41 * | 5.41 * | 4.38 * | 3.93 | 3.80 | 2.52 | 1.96 * | 1.83 | 7.30 |
| 1.5 m | | | 8.90 * | 6.70 | 5.72 * | 3.66 | 3.67 | 2.41 | 2.08 * | 1.73 | 7.45 |
| 0.0 m | | | 8.35 * | 6.25 | 5.51 | 3.45 | 3.56 | 2.31 | 2.34 * | 1.75 | 7.29 |
| -1.5 m | 5.20 * | 5.20 * | 10.12 * | 6.15 | 5.40 | 3.36 | 3.51 | 2.26 | 2.85 * | 1.91 | 6.79 |
| -3.0 m | 8.19 * | 8.19 * | 10.41 * | 6.21 | 5.41 | 3.37 | | | 3.65 | 2.36 | 5.87 |
| -4.5 m | | | 7.94 * | 6.45 | | | | | 5.36 * | 3.82 | 4.25 |













 : Rating over front.
 : Rating over side or 360°.

- Lifting capacities are in compliance with ISO 10567:2007(E).
- The load point is at the end of the arm.
- * = The nominal loads are based on hydraulic capacity.
- The nominal loads shown do not exceed 75% of tipping loads or 87% of hydraulic lifting capacity.
- For lifting capacity with bucket, simply subtract the actual weight of the bucket from the values.
- The configurations indicated do not necessarily reflect the standard equipment of the machine.

LIFTING CAPACITIES DX140LC-7K

ARTICULATED BOOM • W/O BUCKET

(UNIT: 1000 KG)

| A | 3.0 m | | 4.5 m | | 6.0 m | | 7.5 m | | Max. reach | | A |
|---|---|---|---|---|---|---|---|---|---|---|---|
| |  |  |  |  |  |  |  |  |  |  | |



Articulated boom 4.98 m • Arm 2.5 m • Shoe 700 mm • Counterweight 2.2 t • Dozer up

| | | | | | | | | | | | |
|--------|---------|------|--------|--------|--------|------|--------|------|--------|--------|------|
| 7.5 m | | | | | | | | | 2.76 * | 2.76 * | 4.43 |
| 6.0 m | | | 2.89 * | 2.89 * | | | | | 2.29 * | 2.29 * | 5.98 |
| 4.5 m | | | 3.38 * | 3.38 * | 3.39 * | 2.76 | | | 2.13 * | 2.13 * | 6.88 |
| 3.0 m | | | 4.48 * | 4.09 | 3.78 | 2.66 | | | 2.11 * | 1.92 | 7.36 |
| 1.5 m | | | 5.65 | 3.80 | 3.64 | 2.54 | 2.24 * | 1.82 | 2.20 * | 1.82 | 7.50 |
| 0.0 m | | | 5.44 | 3.62 | 3.54 | 2.44 | | | 2.42 * | 1.85 | 7.34 |
| -1.5 m | 7.42 * | 6.55 | 5.37 | 3.56 | 3.50 | 2.41 | | | 2.86 * | 2.03 | 6.85 |
| -3.0 m | 10.16 * | 6.67 | 5.43 | 3.61 | | | | | 3.62 | 2.50 | 5.94 |

Articulated boom 4.98 m • Arm 2.5 m • Shoe 700 mm • Counterweight 2.2 t • Dozer down

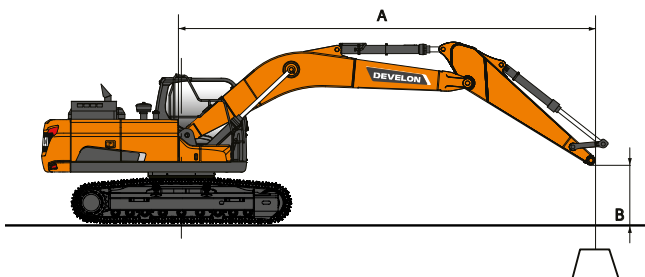
| | | | | | | | | | | | |
|--------|---------|--------|--------|--------|--------|--------|--------|--------|--------|--------|------|
| 7.5 m | | | | | | | | | 2.76 * | 2.76 * | 4.43 |
| 6.0 m | | | 2.89 * | 2.89 * | | | | | 2.29 * | 2.29 * | 5.98 |
| 4.5 m | | | 3.38 * | 3.38 * | 3.39 * | 3.39 * | | | 2.13 * | 2.13 * | 6.88 |
| 3.0 m | | | 4.48 * | 4.48 * | 3.83 * | 3.52 | | | 2.11 * | 2.11 * | 7.36 |
| 1.5 m | | | 5.79 * | 5.17 | 4.44 * | 3.39 | 2.24 * | 2.24 * | 2.20 * | 2.20 * | 7.50 |
| 0.0 m | | | 6.75 * | 4.97 | 4.97 * | 3.29 | | | 2.42 * | 2.42 * | 7.34 |
| -1.5 m | 7.42 * | 7.42 * | 7.12 * | 4.90 | 5.22 * | 3.25 | | | 2.86 * | 2.72 | 6.85 |
| -3.0 m | 10.16 * | 9.76 | 6.84 * | 4.96 | | | | | 3.82 * | 3.36 | 5.94 |



 : Rating over front.
 : Rating over side or 360°.

- Lifting capacities are in compliance with ISO 10567:2007(E).
- The load point is at the end of the arm.
- * = The nominal loads are based on hydraulic capacity.
- The nominal loads shown do not exceed 75% of tipping loads or 87% of hydraulic lifting capacity.
- For lifting capacity with bucket, simply subtract the actual weight of the bucket from the values.
- The configurations indicated do not necessarily reflect the standard equipment of the machine.